



STANDARDS

- CRN Certified
- MTR Reports available
- Double block/double isolation and bleed
- In-line repairable
- Full port, through conduit
- Press fit seats & mechanical sealing

J Flow Controls **KE Series**

Through Conduit, Double Expanding Gate Valves

FEATURES & BENEFITS

- Full bore design, allowing for scraper, shot tap cutters and pigs. Negligible pressure drop
- Special top entry design, allowing for in-line maintenance
- Valve cavity is isolated from the flow both in fully open and fully closed position. Stem packing can be replaced in-line in fully open and fully closed position after cavity pressure released from body vent drain plug.
- Automatic pressure relief system will release the over pressure in the cavity, protect the valve
- Can be installed with pipe at any angle, vertical, horizontal, reverse position
- Multi-operator types: handwheel, gear box, pneumatic, electric, etc.
- Extended bonnet and stem
- Equalizing hole in gate

APPLICATIONS & INDUSTRIES

- Offshore/onshore drilling & production
- Oil & gas transportation isolation
- Upstream gas compression isolation
- Pig traps isolation
- Hot steam
- Oil tank storage
- Block & bleed applications

CERTIFICATIONS

- Face-to-face dimension: ANSI B16.10
- Flanged dimension: ANSI B16.5
- Wall thickness: ANSI B16.34
- Flanged finish: MSS SP-6

WORKING PRINCIPLE OF THE KE SERIES DOUBLE EXPANDING GATE VALVE

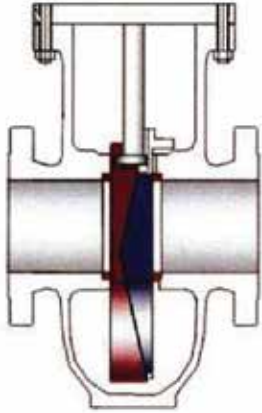

Seal Closed

In the fully closed position the segment has engaged with an end-stop and the gate is wedged downward, expanding the segment and gate so that they form a tight mechanical closure against the upstream and down-stream seats. Valve is in sealed position

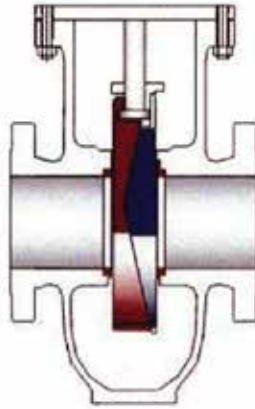

Mid-Travel

During travel towards open or close, the gate slides across the wedge angle of the segment, collapsing the assembly so that it travels freely between the seal faces. The lever lock gate holds the mechanism in the neutral position until closed and fully open position expansion is required

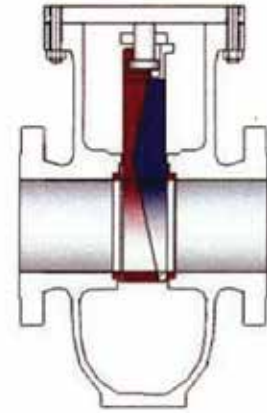

Fully Open

When the bore in the segment is aligned with the conduit bar, an end-stop prevents further travel and the gate slides across the wedge angle, expanding the gate and the segment isolating the flow from the body

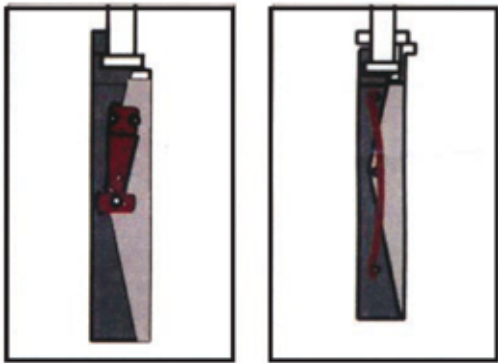

For size 8" and above, the gate and segment are connected with lever mechanism

For size 2" to 6", the gate and segment are connected with a spring

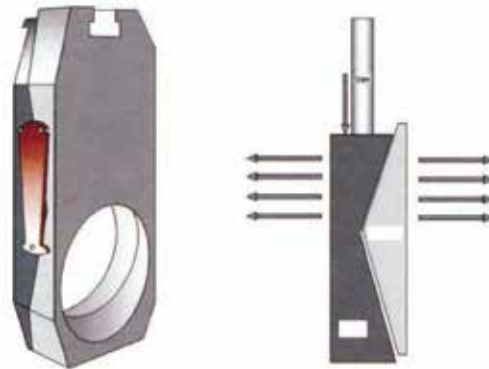









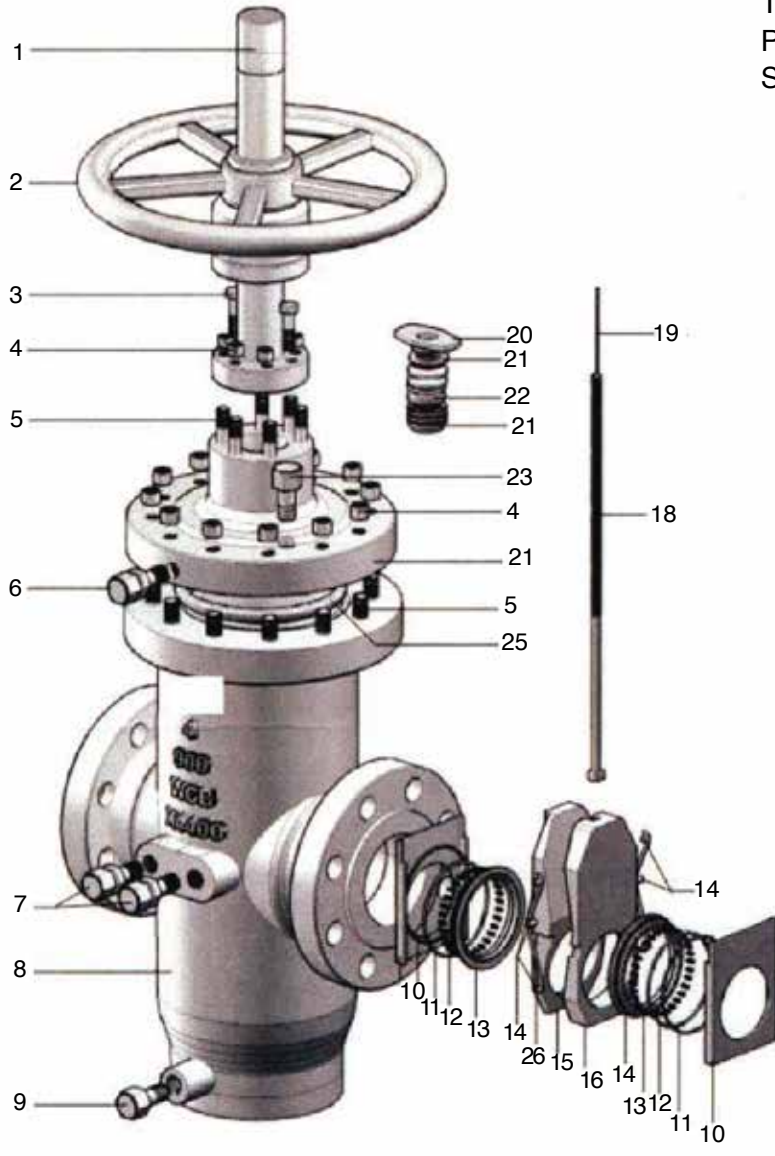







The lever arm is held parallel to the gate faces by the skirt plate, while the assembly is moving through its stroke. Near end-of-travel, the skirt allows the lever to tilt. The gate and segment slide against their angled faces, creating the expanding seal action. In their final position, the gate and segment are mechanically secured in place. The skirt plates are guide rails, align the gate and segments with the seat.

KE Series Through Conduit, Double Expanding Gate Valves

BODY OF CONSTRUCTION 2" THROUGH 6"

Through conduit double expanding gate valve
 Pressure class 300#, 600#, 900#
 Size 2" - 6"



- Double Block & Bleed 
- Safe Release 
- Reliable Seal 
- Fire Safe 
- Cleaning Pipe 
- Emergency Seal 
- Special Seat 
- Draining 
- Extended Stem 
- Various Operation 
- Various End Connections 
- Diversity of Body Materials 
- Diversity of Seat Materials 
- Various Control Systems 
- Reliable Operation 
- Bearing Pipe Stress Safety 

Item	Part Name	Item	Part Name	Item	Part Name	Item	Part Name
1	Stem Protector	8	Body	15	Gate	22	Lantern Ring
2	Handwheel	9	Body Drain Plug	16	Segment	23	Body Vent Plug
3	Packing Adjust Bolt	10	Gate Seat Skirt	17	Segment Seat Skirt	24	Bonnet
4	Nut	11	O-Ring	18	Stem	25	Bonnet Gasket
5	Stud	12	Spring	19	Indicator Rod	26	Connection Spring
6	Stem Grease Injection Fitting	13	Seat Ring	20	Packing Gland		
7	Sealant Injector Fitting	14	Spring Pin	21	V Packing Ring		

KE Series Through Conduit, Double Expanding Gate Valves

BODY OF CONSTRUCTION 8" THROUGH 40"

Through conduit double expanding gate valve
 Pressure class 300#, 600#, 900#
 Size 8" - 40"

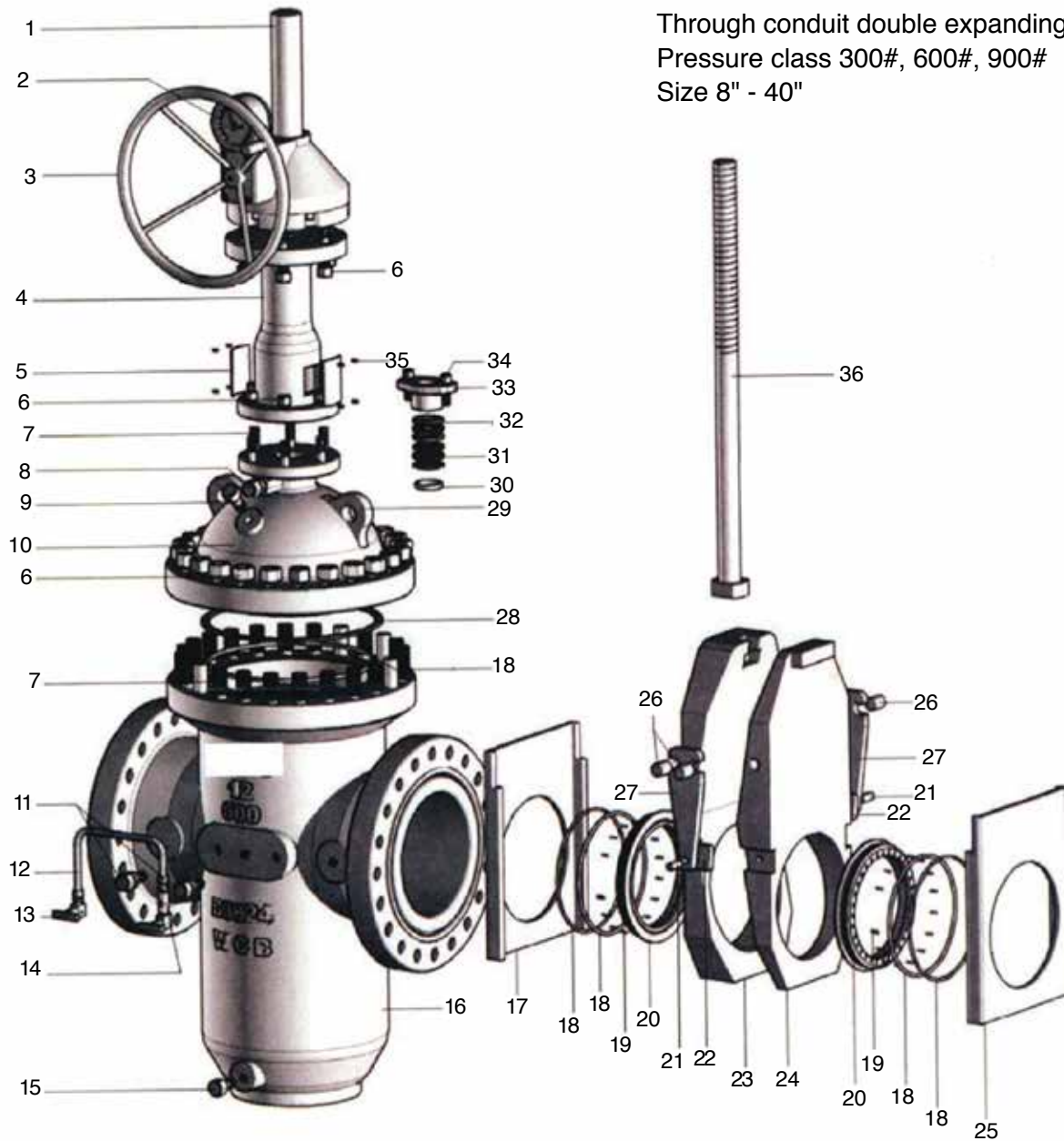

Item	Part Name	Item	Part Name	2Item	Part Name	Item	Part Name
1	Stem Protector	10	Bonnet	19	Spring	28	Bonnet Gasket
2	Indicator	11	Sealant Injector Fitting	20	Seat Ring	29	Lift Lug
3	Handwheel	12	Tubing	21	Shoe Pin	30	Bearing
4	Yoke	13	Needle Valve	22	Lever Lock Shoe	31	Latern Ring
5	Protection Shell	14	Check Valve	23	Gate	32	Graphite Packing
6	Nut	15	Body Drain Plug	24	Segment	33	Packing Gland
7	Stud	16	Body	25	Segment Seat Skirt	34	Gland Adjust Bolt
8	Stem Injector Fitting	17	Gate Seat Skirt	26	Lever Lock Arm Pin	35	Screw
9	Vent Fitting	18	O-Ring	27	Lever Lock Arm	36	Stem

KE Series Through Conduit, Double Expanding Gate Valves

DIMENSION OF DOUBLE EXPANDING GATE VALVE: CLASS 300#

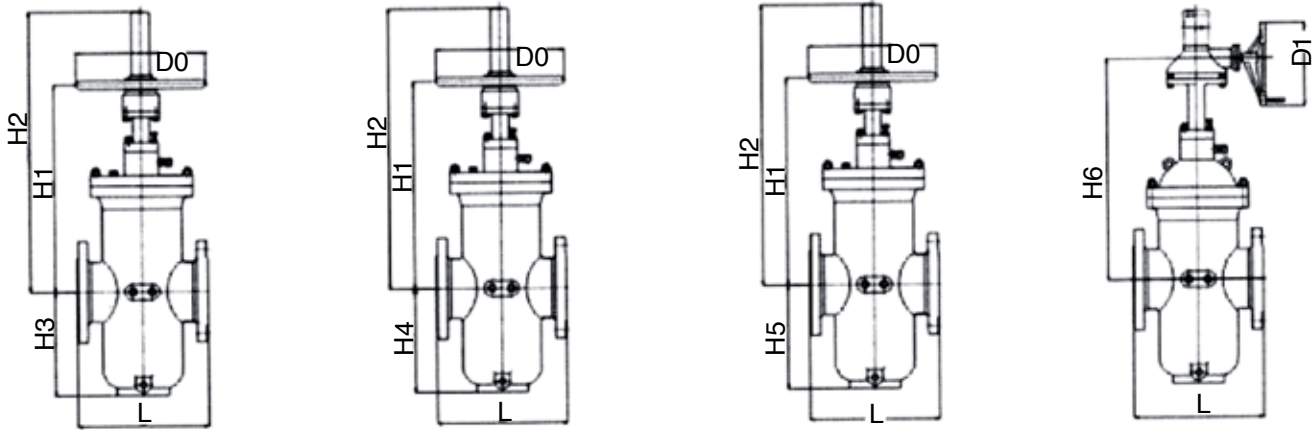

Size (in)	Bore	L			H1	H2	H3	H4	H5	H6	AxB	D0	D1	Approx Weight (lbs)		
		RF	RTJ	WE										RF	RTJ	WE
2	49	8.50	9.13	8.50	13.9	20.1	6.10	4.33	3.54	-	2.8x5.0	9.84	-	170	179	168
2-1/2	62	9.49	10.1	9.49	15.0	22.8	6.73	5.04	3.78	-	2.8x5.1	9.84	-	185	185	179
3	74	11.1	11.7	11.1	15.7	23.4	8.62	5.28	4.06	-	3.8x5.7	9.84	-	231	234	216
4	100	12.0	12.6	12.0	20.7	27.4	10.1	7.32	4.72	22.2	3.3x7.1	9.84	12.0	478	509	448
5	125	15.0	15.6	15.0	25.0	32.5	10.9	8.07	5.43	27.4	3.9x9.6	13.8	12.0	494	500	463
6	150	15.9	16.5	15.9	25.8	37.4	12.3	9.37	6.10	29.1	3.9x10.6	13.8	12.2	586	617	525
8	201	16.5	17.1	16.5	31.0	42.3	16.9	11.2	7.68	33.9	5.5x13.8	13.8	12.2	1019	1049	895
10	252	18.0	18.6	18.0	36.6	49.5	19.6	13.9	8.90	41.6	5.5x16.1	17.7	12.2	1512	1590	1327
12	303	19.8	20.4	19.8	43.5	61.6	22.5	16.1	10.1	48.4	7.1x18.1	17.7	17.7	2130	2161	1929
14	334	30.0	30.6	30.0	46.3	64.0	25.6	18.1	11.3	51.4	7.9x20.9	29.5	17.7	3086	3133	2747
16	385	33.0	33.6	33.0	57.3	77.8	29.0	19.7	13.0	61.7	7.9x22.8	33.5	29.5	4352	4414	3889
18	436	36.0	36.6	36.0	59.2	82.7	31.6	22.3	13.8	68.3	7.9x25.6	33.5	33.5	5895	5957	5000
20	487	39.0	39.8	39.0	71.7	92.5	34.5	25.6	15.2	71.7	7.9x27.6	33.5	33.9	7438	7222	6512
22	538	43.0	43.9	43.0	-	99.2	37.8	26.8	17.3	76.5	7.9x29.5	33.5	33.9	9229	9244	8395
24	589	45.0	45.9	45.0	-	111	42.5	29.1	18.8	84.7	15.8x32	33.5	33.9	11574	11605	10525
26	633	49.0	50.0	49.0	-	120	46.1	30.7	20.0	86.7	12.2x37	33.5	33.9	13550	13565	12253
28	684	53.0	54.0	53.0	-	126	48.4	32.5	22.1	95.1	24x32	33.5	33.9	16297	16356	14537
30	735	55.0	56.0	55.0	-	138	52.0	37.4	22.6	98.4	23x41	33.5	33.9	19105	19121	17099
32	779	60.0	61.1	60.0	-	143	55.0	40.9	23.6	107	31	33.5	33.9	22902	22932	20648
34	830	64.0	65.1	64.0	-	157	58.3	42.5	-	112	34	33.5	33.9	27315	27346	24784
36	874	68.0	69.1	68.0	-	167	61.0	45.7	-	116	35	33.5	33.9	31420	31790	28488
38	925	72.0	*	72.0	-	-	65.0	*	-	122	39	-	33.9	34568	34568	30463
40	976	82.0	*	82.0	-	-	66.5	*	-	127	43	-	33.9	36976	36976	32315
42	1020	84.0	*	84.0	-	-	70.5	*	-	132	45	-	33.9	38735	38735	33735
48	1166	90.0	*	90.0	-	-	80.3	*	-	150	24x49	-	33.9	58026	58026	54322
54	1312	*	*	*	-	-	89.4	*	-	167	27x53	-	33.9	-	-	-
56	1360	98.0	*	98.0	-	-	92.5	*	-	170	30x59	-	33.9	70063	70063	64816
60	1458	*	*	*	-	-	98.4	*	-	175	30x63	-	33.9	-	-	-

KE Series Through Conduit, Double Expanding Gate Valves

DIMENSION OF DOUBLE EXPANDING GATE VALVE: CLASS 600#

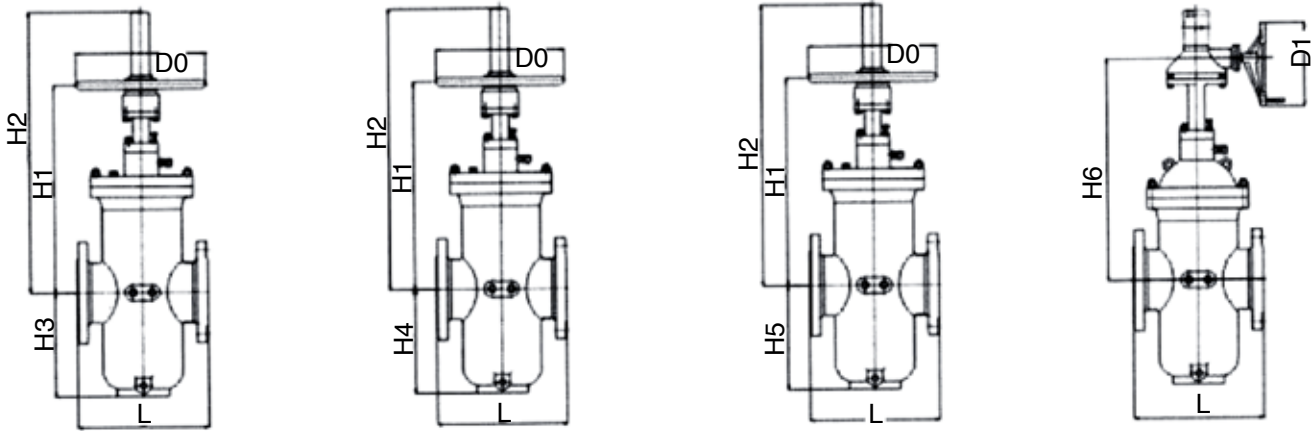

Size (in)	Bore	L			H1	H2	H3	H4	H5	H6	AxB	D0	D1	Approx Weight (lbs)		
		RF	RTJ	WE										RF	RTJ	WE
2	49	11.5	11.5	11.5	17.9	23.8	6.02	4.84	4.21		4.33	9.84		247	247	201
2-1/2	62	13.0	13.0	13.0	19.7	24.7	6.69	5.43	4.72		4.53	9.84		324	324	309
3	74	14.0	14.1	14.0	20.7	25.5	9.02	6.30	5.12	26.8	4.41	13.8	12.0	340	340	293
4	100	17.0	17.1	17.0	21.7	31.2	10.0	7.24	5.71	27.4	5.51	17.7	12.0	478	478	386
5	125	20.0	20.1	20.0	25.9	35.0	11.8	8.46	6.38	27.6	6.30	17.7	12.0	802	802	586
6	150	22.0	22.1	22.0	26.0	37.4	13.4	9.92	7.28	35.4	7.09	21.7	12.0	950	950	802
8	201	26.0	26.1	26.0	31.2	43.2	16.3	11.4	8.11	36.6	9.84	25.6	17.7	1495	1495	1173
10	252	31.0	31.1	31.0	36.8	53.5	20.5	13.6	10.0	41.0	11.0	29.5	17.7	2315	2315	1790
12	303	33.0	33.1	33.0	46.7	62.5	23.2	16.1	11.6	49.2	12.0	33.5	25.2	4167	5401	2932
14	334	35.0	35.1	35.0	54.3	70.5	27.6	17.8	13.3	53.2	13.4	33.5	25.2	5185	5185	4200
16	385	39.0	39.1	39.0		80.0	30.7	20.3	14.4	61.8	16.5		31.5	6219	6219	5093
18	436	43.0	43.1	43.0		84.7	33.5	23.6	15.8	64.6	17.7		31.5	8272	8272	6636
20	487	47.0	44.1	47.0		93.7	37.4	25.6	16.3	71.7	17.7		31.5	9244	9244	7963
22	538	51.0	51.4	51.0		99.2	40.9	28.7	18.9	75.6	20.5		31.5	12006	12022	10093
24	589	55.0	55.4	55.0		111	45.3	31.1	19.9	85.0	23.6		33.9	14939	14969	12284
26	633	57.0	57.5	57.0		120	48.4	-	20.9	92.1	27.6		33.9	17531	17547	15401
28	684	61.0	61.5	61.0		133	51.6	35.4	21.6	95.5	29.5		33.9	21266	21266	18827
30	735	65.0	65.5	65.0		143	56.3	-	26.0	99.6	29.9		33.9	24661	24676	22192
32	779	70.0	70.6	70.0		153	59.1	-	26.8	108	30.7		33.9	29352	29370	26389
34	830	76.0	76.6	76.0		163	62.2	-		113	30.9		33.9	34877	34939	31791
36	874	82.0	84.6	82.0		172	65.5	-		124	31.7		33.9	37038	37099	33334
38	925	88.0	-	88.0		181	68.9	-		129	32.7		33.9	40741	40803	38581
40	976	94.0	-	94.0		192	72.1	-		132	41.3		33.9	45680	45741	42285
42	1020	98.0	-	98.0		203	75.6	-		136	44.1		33.9	50618	50680	44754
48	1166	106	-	106		231	85.4	-		153	46.5		33.9	57100	57161	51853

KE Series Through Conduit, Double Expanding Gate Valves

VALVE DATA FOR CHOOSING ACTUATOR - DOUBLE EXPANDING GATE VALVE

Size (in)	Class	ANSI Working Pressure psi	Stem Thread			Recommended Operating Torque R-Lb	Maximum Allowable Thrust Lb	Maximum Allowable Torque Rt-Lb	Total Stem Travel in	Turns to Open
			Size in	Pitch in	Lead in					
3	600	1500	1.000	0.200	0.200	31	19944	153	4.03	20
	900	2250				47				
4	600	1500	1.250	0.250	0.250	63	31868	305	4.88	19.5
	900	2250				95				
6	300	750	1.500	0.286	0.286	73	48000	546	7.06	25
	600	1500				146				
	900	2250				218				
8	300	750	2.000	0.333	0.333	161	94177	1380	9.25	28
	600	1500				322				
	900	2250				483				
10	300	750	2.250	0.333	0.333	259	127226	2041	11.38	34
	600	1500				517				
	900	2250				776				
12	300	750	2.250	0.333	0.333	346	127226	2041	13.31	40
	600	1500				692				
	900	2250				1038				
16	300	750	2.500	0.333	0.333	566	168876	2944	16.63	50
	600	1500				1131				
	900	2250				1697				
20	300	750	2.875	0.400	0.400	1027	220220	4460	22.00	55
	600	1500				2063				
	900	2250				3080				
24	300	750	2.63	0.333	0.666	690	175865	3994	28.13	42
	600	1500				3449				
30	300	750	3.130	0.400	0.800	3063	250000	6800	32.88	41
	600	1500				6126				

KE Series Through Conduit, Double Expanding Gate Valves

HOW TO ORDER

Series	Body	Trim	Flanged End Connections
KE	WCB Carbon Steel	NW1 Standard	F150 ANSI 150
	WCB NACE Carbon Steel	CN1 Corrosive	F300 ANSI 300
	WCC Carbon Steel	GH1 High Temp	F600 ANSI 600
	WC6 Carbon Steel	GH2 High Temp	F900 ANSI 900
	LCC Impact Test Carbon Steel	DW1 Low Temp	F1500 ANSI 1500
	LCC Carbon Steel	DW2 Low Temp	F2500 ANSI 2500

J Flow Controls®
4665 Interstate Drive
Cincinnati, OH 45246
513-731-2900
jflowcontrols.com

While the information and specifications contained in this literature are believed to be accurate, they are supplied for informative purposes only and should not be considered certified or a guarantee of satisfactory results. Nothing contained herein is to be construed as a warranty or guarantee, express or implied, regarding any matter with respect to this product. Because J Flow Controls® is continually improving and upgrading its product design, the specifications, dimensions and information contained herein are subject to change without notice.