

**Important Notice: The following information should be read and understood before proceeding with the installation.**

Jflow High Performance Butterfly Valves have been designed and manufactured for fluid control handling in suitable mechanical systems. This instruction manual includes installation, operation and maintenance information for the Jflow high performance butterfly valve. It is important to follow the instructions to assure valve installation and safe trouble-free operation.

Failure to follow these instructions may result in reduced valve performance and may cause loss of manufacturer's warranty. This manual addresses manually operated valves including lever and gear operated only. For complete actuation, options and accessories information, consult the specific device's manual.

## 1 General Safety

At all times personal safety equipment should be worn, safety glasses, safety boots with crush-resistant toe caps, hard hat, gloves should be worn for pinch protection and handling valves exposed to chemicals.



Warns against an unsafe situation or practice that, if not avoided, could result in damage



Warns against an unsafe situation or practice that, if not avoided, could result in minor injury.



Warns against an unsafe situation or practice that, if not avoided, could result in severe injury.

## 2 General Information

The selection of the valve design and materials of construction as related to the specific service application is the sole responsibility of the end user. All Jflow HPBFV have identification mark (Casting or in information tag) casted or attached in valve body. Important information including valve size, class, materials of construction, and pressure ratings are shown. Before apply, review corrosive effects of the media to be used in the valve and assure it is compatible with the valve materials of construction. Do not install the valve where the pressure/temperature ratings can be exceeded. As temperature increases, the safe working pressure decreases. The pressure/Temperature ratings are based on B16.34 and stated in Jflow HPBFV catalogue Temperature and Pressure rating chart. Valve should be regularly maintained as mentioned in Maintenance section. Valves used in services where erosion or other detrimental situations can occur should be inspected on regular basis.

## 3 Transportation

- 1) Valve weight over 50Lbs should be transported using equipment or a machine. Not a man power alone. Please refer to product catalogue on details of valve unit weight.
- 2) Protect the valve sufficiently before transportation to avoid damage. Damage may cause leakage or corrosion.
- 3) Use containers for ocean transport. Use a covered vehicle for inland transportation to avoid exposure to wind and rain. If an uncovered vehicle is used, cover the product with a protective waterproof cover.
- 4) Do not throw the product and do not apply a heavy load.
- 5) The valves should be secured during transport from shifting or falling and stored without heavy loads on top to avoid damage, especially to the valve seat and disc.

## 4 Packing & unpacking

- 1) All Jflow High Performance BFV are shipped in the full-closed position.
- 2) All valves are packed with bubble wrap and carton box protection around the main valve body for valves up to 12" and bubble wrap and plywood protection for sizes 14" and up. Be careful not to damage the edge of disc, seat, and retainer ring surface.
- 3) Individual carton box protection packing include all necessary information which you can verify information such as the pressure class, nominal size and materials.
- 4) These bubble wrap or plywood protection cover on face and carton box packing cover should remain on the valve until actual installation into piping.
- 5) Do not leave the valve unpacked for long periods of time to prevent adherence of dust and harmful substances and deterioration.
- 6) Be careful not to damage the product with a cutter when unpacking.

## 5 Storage

- 1) Storage condition is very important to prevent degradation in performance, contamination, and discoloration and material deterioration.
- 2) The valves must be stored in a dry environment with no dust or water droplets while avoiding direct sunlight, low or high temperature and humidity. Protected from temperature extremes and possibility of damage. Recommended to store indoors under room temperature range with humidity 60% or less without removing the bubble wrap & carton box packaging or the protective material attached to the valve.

- 3) High humidity may reduce the strength of the carton box and the packaging may be broken, which may results in damage of the product. Be adequately careful not to get the packing wet.
- 4) If the valves are to be stored for long term storage they should be operated open/close once every three months.
- 5) The valve body is made from carbo steel or Stainless Steel and rust can appear on inside surface. This will not affect valve performance. Special care sh uld be taken to prevent damage to the disc edge and sealing surface.
- 6) Do not drop, overturn, or vibrate the valve and do not apply a heavy load to the product during storage,

## 6 Pre-Installation

- 1) Determined valve orientation. The valve can be installed in any position or direction. However it is preferred to install the valve in flow direction matches the direction arrow cast in valve body. Preferred flow direction is with the seat retaining ring facing upstream. This allows b tter protection for the seat from particles flowing in the media and from sediment build-up at stem base giving optimal valve service life. This is very important for stem service application due to the high travel velocities.
- 2) Prior to installing the valve, it is important to make sure the ID of the pipe and pipe flanges are large enough to allow the disc edge to swing into the opening without interference. Damage to the disc edge can severely affect the performance of the valve. Please refer to “**Disc clearance chart**” for more information.
- 3) Prior to installation, make sure that levers, gear operators, or actuators are properly installed and that t e stops are properly set for open and close positions. The valve is supplied with an internal over-travel stop, there may be clearance between the back of the disc and stop. **WARNING: Do not use the over-travel stop to position the disc or limit the travel of actuators, it may result in leakage to the seat & damage the valve.**
- 4) Before installing the valve, ensure that the lever or gear operator is installed such that the position indication matches the position of the valve disc. For lever operated valve, the lever should be in parallel with the disc. For gear operated valves, the dial indicator on the gear should match the position of the valve disc.
- 5) Before installing the valve, inspect the valve body port and associated equipment for any damage that may have occurred and for any foreign matter that may have collected in shipping or storage. Make certain the body interior is clean, the seat facings and disc edge surface are undamaged.
- 6) Make sure the valve rating & materials are sufficient for the service which the valve will be installed. **WARNING: Personal injury or property damage may result if the valve is installed where service conditions could exceed the valve ratings.**
- 7) Before installing the valve, inspect the piping and remove all dirt, welding slag, rust and scale from the piping and flange faces that could cause leakage. It is advisable to install a strainer upstream of the valve to prevent contamination from entering the valve. It is very important for long trouble free service to keep the valve free of all contamination that many damage the sealing surfaces
- 8) Ensure that the pipe line and mating flanges are properly aligned, Align the primary side pipe with the secondary side pipe properly and make sure the pipes are parallel and there is no distortion. If the alignment is not proper, external leakage, seat leakage, or faulty operation may occur.

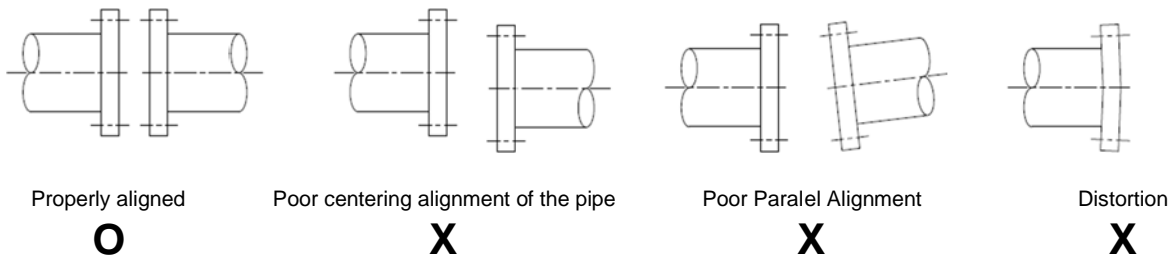

- 9) When installing, do not stand on the valve or insert the valve by forcing or heating it. There should be at least 1 inch extra space between piping more than valve face to face sizes.
- 10) When connecting the valve to the piping, actuator facing downward is not allowed & Be careful of the stem direction when piping conditions are as shown

### Installing a valve at a pump outlet

**Incorrect Installation**  
**X**

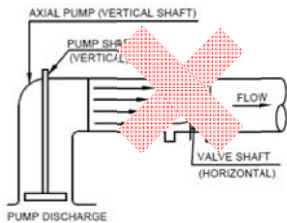
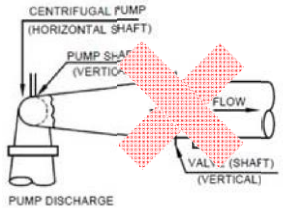
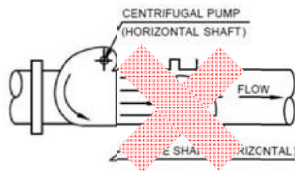

**Correct Installation**  
**O**

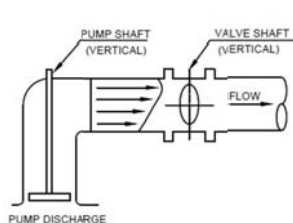
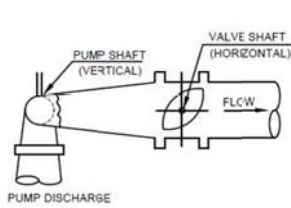
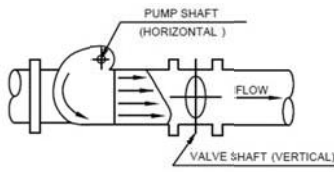

### Installing at a elbow or a reducer

**Incorrect Installation**  
**X**

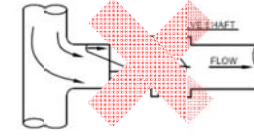

**Correct Installation**  
**O**

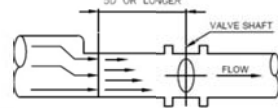
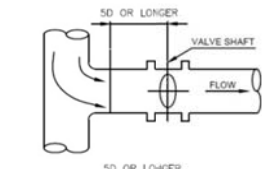
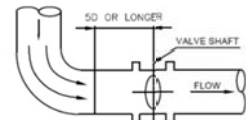

### Combination of a control valve and stop valve

**Incorrect Installation**  
**X**

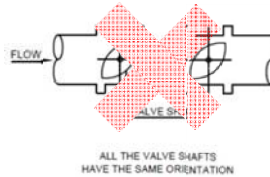

**Correct Installation**  
**O**

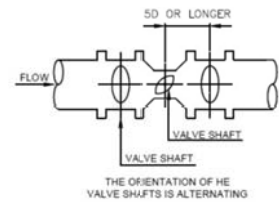

**WARNING: Do not remove the locking lever, gear or other actuators while the valve is under pressure.**

- 11) When selecting the bolt and stud, please refer the “flange bolting selection guide”. **WARNING: Improper bolt and stud lengths could results in leakage at the flange resulting in serious injury.**

## 7 Installation

At installation, read “Pre-Installation” in section 6 thoroughly and then perform installation in accordance with the following procedure. **CAUTION: When installing a non-return valve, pump, or flexible joint made of rubber with this product, insert a short pipe between the part and this product. Otherwise, the disc may make contact with the other device during operation, resulting in faulty operation and leakage.**

- 1) Clean the flange face that will make contact with valve. If there is rust or some other foreign material sticking face with a suitable cleaning fluid (alcohol, neutral detergent, etc.).
- 2) Remove foreign material from the piping completely before connecting valve to the piping.
- 3) Before installation or removal work, set the valve disc in the full-close position.
- 4) After aligning both flanges, insert the piping bolts and secure the product to prevent it from dropping.
- 5) Insert jack bolts in the position to wide the distance between the flanges. Push the flanges and make the distance between the flanges 6 to 10 mm longer than the valve face-to-face dimension. Do not remove the jack bolts until all the piping bolts are installed.
- 6) Do not suspend this product by hanging a book, etc. on the handle. Suspend the product by tying down a well balanced position, such as the neck section of the product, with material that does not damage the body, such as a nylon sling.

- 7) A pressure direction (flow direction) is specified for this product. When installing, make the pressure direction of the valve match the direction indicated by the arrow on the valve body. Insert the product while taking care not to damage the valve flange face. At installation, if the product is pushed in the flange forcibly, the flange face will be damaged, which will cause leakage. Be sure to widen the distance between the flanges using jack bolts, etc. before inserting the product. Insert piping gaskets between the end faces of the valve and the pipe flange faces.
- 8) When valve inserted completely, insert the piping bolts to support the alignment rib.
- 9) After all the piping bolts are installed, remove the jack bolts.
- 10) Align the flanges with the product accurately. Tighten the piping bolts with the following procedures so as not to tighten the bolts on one side too much or too little. For this product, fluid is sealed by the seat ring compressed with the force as a result of the pipe flange compressing the gasket. When connecting the product to the piping, align the center of this product with the center of the flange to press the Seat ring accurately. The alignment for piping work becomes easy by using the alignment rib. If this product is operated while the centers are not aligned, breakage, faulty operation, external leakage or seat leakage may occur.

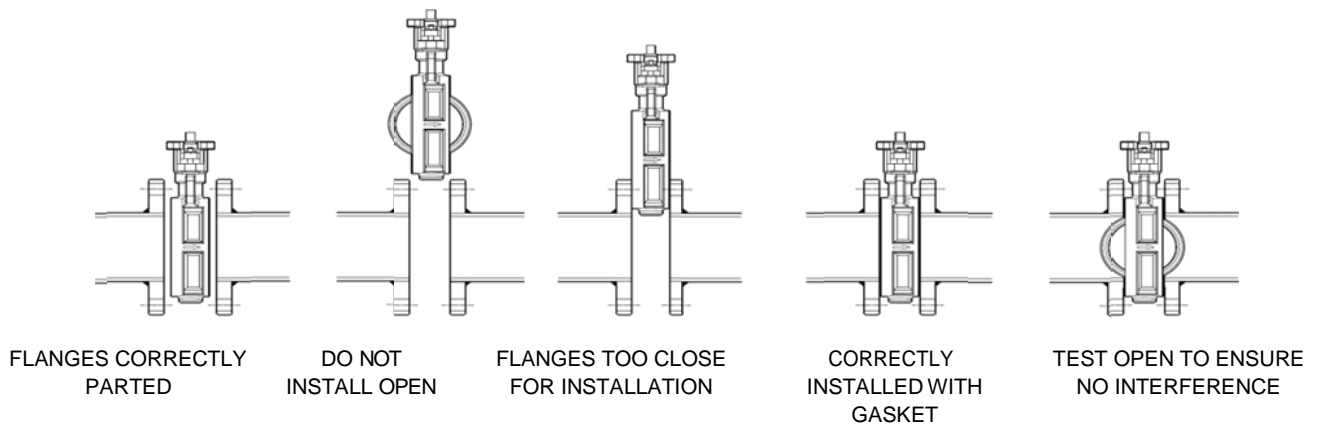

### Piping bolt Tightening Procedure

- 1) Clean the bolts and nuts and apply lubricant to them. Do not use rusty or damaged bolts and nuts.
- 2) Tighten the bolts and nuts by hands. Tighten the bolts and nuts in any desired order with approx 20% of specified tightening torque.
- 3) Tighten the bolts and nuts, alternate diagonally with approx 70% of the specified tightening torque.
- 4) Tightening the bolts and nuts, alternate diagonally with approx 100% of the specified tightening torque.
- 5) Bolts that are tightened once may become loose due to stress relaxation of the piping gaskets. Be sure to perform retightening repeatedly until the bolts and nuts are tightened evenly

### Diagram of Bolt tightening sequence

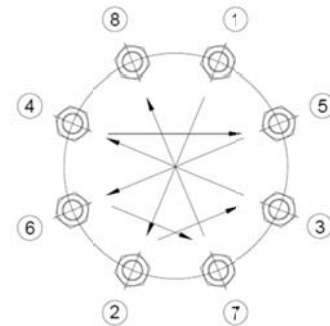

- 11) For accurate alignment between the flanges and valve, tighten the flanges at both ends temporarily and tighten this product finally first.
- 12) After installation, open and close the product to verify that the operations from/to full-open to/from full-close are smooth.

**WARNING : Personnel should take precautions to wear the appropriate personal protection equipment such as safety shoes with toe protection, gloves, safety glasses and hard hat. Personnel installing the valves should have the mechanical and handling training of such equipment including rigging and hoisting techniques. Any Process in the pipe lines should be identified to be safe to work prior to starting. The line should be depressurized and drained before installing the valves.**

## 8 Stop adjustment

- 1) HPBFV can be actuated by manual lever, a manual gear operator or actuators. For any types of operation methods, it is critical that the actuator closed travel limit stop is properly set to match valve disc / seat orientation for proper seal. The open stop adjustment is not critical, Plus or minus  $\pm 5^\circ$  travel is adequate.
- 2) The closed actuator stop should be set before the valve is installed into piping so disc is centered in the seat. Disc front face is parallel with seat retainer faces. Note that the valve has an "over-travel stopper" stops at the disc edge. This "over-travel stopper" is only to keep disc from rotating too far thru the seat. When the disc is properly centered in the seat, the disc edge usually does contact the "over-travel stopper"

## 9 Operation

- 1) The valve can be actuated by manual lever, a manual gear operator, an electric or pneumatic actuator. Turning the valve (as viewed from top) clockwise closes the valve: counter-clockwise opens the valve.
- 2) Due to the double offset design of HPBFV, the different pressure over the disc can cause sufficient torque to open the valves spontaneously. For this reasons, it is important not to remove lever or actuator from a valve that is or will be pressurized
- 3) Lever Operated valve should always be locked securely in desired 10 position indicate plate notch to prevent unexpected disc movement.

## 10 Maintenance

Typical maintenance consists of periodic inspection and exercising cycling of the valve to assure proper function. Valve parts are subject to normal wear and should be inspected and replaced as necessary. Inspection and maintenance frequency depends on the severity of the service conditions. The following periodic preventative maintenance practices are recommended for all high performance Butterfly valve.

- 1) Operate the valve from full open to full close to assure operability
- 2) Check flange bolting for evidence of loosening and correct as needed
- 3) Inspect the valve surrounding area for previous or existing leakage at flange faces or stem.
- 4) Check piping and /or wiring to actuator and related equipment for looseness and correct as needed

Inspection Descriptions	Inspection Points	Inspection Procedure	Countermeasure
Fluid External leakage	Pipe joints	Visual Check	Retightening the piping bolt and nuts. Align the valve center with the pipe center and retighten the piping bolts.
	Bottom & Valve surface	Visual Check	Disassembly and maintenance. Spare part replacement if required. , Valve replacement
	Gland area	Visual Check	Retighten the bolts.
Abnormal noise, Vibration	Appearance of the valve and actuator, Piping around the valve bolts and nuts	Listening Check by touch	Change the valve opening. Review the flow rate and pressure. Retightening the bolts and nuts. Remove the source of vibrations. Disassembly and maintenance. Check for damage of the parts.
Looseness of the bolts and nuts	Bolts and nuts	Visual Check Check by touch	Retighten the bolts and nuts. Retighten the pressure part after reducing pressure.
Seat leakage	Presence or absence of leakage from the secondary side (Flow meter, pressure gauge, drain)	Listening, Visual Check, Measurement	Check the opening and closing positions are correct with the indicator Remove foreign material. Remove the valve from the piping and perform check and cleaning. Replace spare parts.
Valve operation check	Check of opening and closing positions	Visual Check, Operation check	Check that the opening and closing positions are correct with the indicator.
Corrosion and damage of the disc	Disc	Remove the valve from the piping and perform visual check	Valve replacement
Abrasion and damage of the seat	Seat	Remove the seat ring from the piping and perform visual check.	Clean the disc and seat. Replace the parts. Valve replacement if required.

If repair parts or service information is required, please locate valve identification information and supply following information:

- Valve Figure Number or Name
- Valve size / class
- Manufacturer date
- Valve serial Number
- Type of Actuator
- If known, Name of distributor and Purchase order no.

Individual Repair kits are available for each size valve, please contact Jflow for detailed information.

## 11 Precautions before disassembling the valve from the line.

- 1) Fluid flowing in a pipe could be corrosive, toxic, flammable or contaminated. Before removing valve, inspect that no pressure is present in line, either upstream or downstream of the valve. Be sure the line is depressurized and drained.
- 2) Be sure of the pipe line and media, Proper care should be taken for protection against toxic and /or flammable fluids.
- 3) Never remove the operator from the valve while the valve is in the pipeline under pressure
- 4) Following safety precautions are recommended when repairing the valve.
  - Always wear protective glasses or eye shields.
  - Always wear gloves and protective footwear
  - Ensure easy availability of running water
  - Have ready an adequate fire extinguisher if media is flammable.

## 12 Removal of Valve from Piping

- 1) Check to confirm piping has been depressurized and drained.
- 2) Actuate valve until in full closed position.
- 3) Attach appropriate lifting strap or sling to valve neck. Attach other end of strap or sling to secure point weight
- 4) Check to confirm piping has been depressurized and drained.
- 5) Actuate valve until in full closed position.
- 6) Attach appropriate lifting strap or sling to valve neck. Attach other end of strap or sling to secure point weight capable of supporting valve.
- 7) Shut almost completely the disc. Remove all nuts and after all bolts with the exception of the two lowest sustaining the valve.
- 8) Spread the flanges with proper tools and remove valve to substitute seat and disc. (Do not use the valve to spread flanges, because seat damage might be the result)
- 9) Remove valve from between flanges, Remove old gaskets and clean piping flange seal surfaces. Note that any time the valve is removed from between flanges, it if necessary to re-torque seat retainer ring with hex socket bolt

## 13 Seat Replacement Procedure

- 1) Remove valve from piping per procedure.
- 2) Place valve on bench with seat retainer ring face up, Remove hex socket bolt (13) from retainer ring (06).
- 3) Push retainer ring (06) from valve body (01).
- 4) Remove old seat (07) and discard.
- 5) Clean seat cavity and retainer ring (06). Clean and inspect seal surfaces on disc (02).
- 6) Polish edge to remove any small scratches that may interfere with disc (02) and seat (07).
- 7) With valve disc (02) in partial open position. Install new seat (07) into valve body.
- 8) Install retainer ring (06) onto seat and align screw holes. Install hex socket bolt (13) and snug.
- 9) Position valve disc to closed position. Torque hex socket bolt using "cross over" diagonal method
- 10) Open and close the valve to ensure that the seat and retainer ring is properly secured to the body.

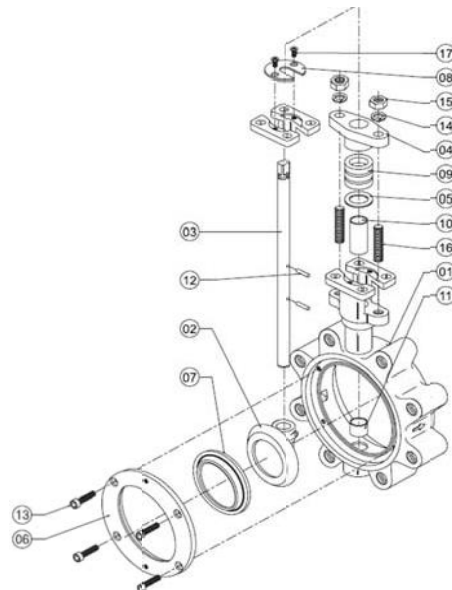

## 14 Gland Packing (Stem Packing) Replacement Procedure

- 1) Remove valve from piping per procedure above.
- 2) Remove actuator and all hardware from top of valve to expose gland flange (4)
- 3) Remove Spring washer (14), Hex Nut (15), Flat head screw (17),
- 4) Fully open the disc and pull up stem and remove Top Retainer (08)
- 5) Push upward on studs bolts (16) and remove gland flange (04) from top of valve.
- 6) Be careful not to damage any seal surfaces. Remove graphite gland packing (09) from valve body(01).
- 7) Clean Packing cavity and Packing etainer (05), Inspect for damage.
- 8) Install new Gland packing (09) into valve body (01), Gland Flange (04), install spring washer (14) and Hex Nut (15), stud bolts (16) evenly to gland flange (04).
- 9) Install Top Retainer (08) with Flat head screw (17).
- 10) Set the disc to the full close position & after installing the actuator, open and close the valve to verify that the operations are smooth.

## 15. Warranty

Jflow High Performance BFV warrants to the original purchaser, for a period of 12 months from date of purchase that its products will be free from defects in workmanship and materials. Not caused or resulting from improper usage application. Improper installation, improper maintenance, repair modification or alternations, or improper storage, shipping and handling, Jflow shall not, caused the defective products to be repaired, replace with a substantially identical products or accept the return of defective products and refund the purchasing price to the original purchaser. Jflow shall bear all normal surface transportation costs to the original purchaser but not for any installation, Engineer other costs incurred in connection with repair or replacement

## 16. Troubleshooting

Trouble	Probable Cause	Countermeasure / Remedy
<b>Leakage from between the body and piping flange faces</b>	The piping bolts are loose or they were not tightened evenly.	After reducing the pressure, loosen the piping bolt, and then retighten them by diagonal sequence. (Refer to "Piping bolt tightening procedures")
	The piping flange face is scratched or there is waste material or other foreign material adhering.	Remove the valve. Repair and clean the piping flange face. After cleaning, install the valve again.
	The flanges or pipes are misaligned.	Remove the valve. Align the flange/pipes and make the flanges/pipes parallel.
	The valve is misaligned.	Insert a proper gasket between the pipe flange and valve.
	No piping gasket is inserted, or improper gasket is inserted.	Retighten the gland bolts. If leakage is not reduced, replace the gland packing.
<b>Leakage from the gland bottom</b>	The gland bolts are loose. The gland packing has worn out or has deteriorated.	Retighten the gland bolts. If leakage is not reduced, replace the gland packing.
	The bottom bolts are loose. The bottom gasket has deteriorated.	If the hexagon bolts are loose, retighten them. If leakage is not reduced, replace the bottom gasket.
	The body and shaft have deformed.	When external force caused by a support secured to the valve body, etc. is applied to the valve in operation, deformation of the body is possible. Check visually for deformation of the shaft. If any deformation is observed, valve replacement is required.
	The body is damaged.	If any cracks or breakage are observed on the body, stop use of the valve immediately and replace the valve.
<b>Valve seat leakage</b>	Wrong material was selected for the fluid application and the parts are corroded.	Replace the valve with one made of the proper material. For details, please contact our sales department
	The product specification does not meet the requirement for the fluid.	Use the product within the product specifications (temperature, pressure, flow rate, fluid type.)
	There is damage to the disc or seat ring due to the presence of foreign material inside the piping.	When the Seat is damaged, replace the Seat. If any abnormality is observed on the disc edge, replace the valve.
	The full-close position of the disc is changed. (The actuator installation bolts are loose, etc.)	Clean the valve seat and body stop (3.6.3) and adjust the full-close position correctly (5.5). In addition, check that there is no problem with the actuator output.
	There is torsion of the shaft due to increase in the opening & closing torque.	Replace the valve.
	Pressure between the Seat and the disc is not even due to uneven tightening of the piping bolts.	Loose the piping bolts and realign the valve and the flange. Then retighten the piping bolts. (Refer to "Piping bolt tightening procedures")
	Wearing and deterioration of the Seat & ring due to long period of use or high frequency of opening and closing operations.	Replace the Seat.



### 16. Troubleshooting

Problem	Main Cause	Countermeasure / Remedy
<b>The valve does not work. Faulty operation</b>	The disc interferes with the piping or other devices.	Insert a short pipe or spacer between the valve and flange to avoid interference. (section 6.1) In this case, remove and check the disc sealing part because there is a high possibility that it is damaged.
	The valve is deformed or damaged.	Check the appearance of the body, disc and shaft to ensure that there is no deformation, dent, damage, corrosion, etc. If any of these are observed, replace the valve.
	Actuator parts are damaged.	For details, refer to the instruction manual of the actuator.
	The piping bolts are loose or tightened unevenly. The valve is misaligned. The pipe flanges are misaligned, are not parallel, or distorted.	If tightening force of the bolts is uneven or the contact areas are not equal, the valve seat compression is uneven and the torque any increase. Loose the bolts and retighten them by diagonal sequence. (Refer to "Piping bolt tightening procedures")
	Increased torque due to presence of foreign material in the piping.	Set the valve to the full-open position and flush the foreign material out to remote it. In this case, remove and check the disc sealing part because there is a high possibility that it is damaged.
	Powdered foreign material inside the piping enters the bearings.	If rust powder or powdered foreign material is inside the piping, any foreign material which entered the bearings may interfere with the shaft rotation. If there is a possibility of this remove the valve and clean it.
	The product specifications do not conform to the fluid specifications.	For automatic valves, the actuator size is selected in accordance with the working conditions (temperature, pressure, flow rate, fluid type). If the working conditions are changed, the valve may not work due to insufficient actuator torque. Please contact our sales department.
	The actuator rated output is not available. (For automatic valves)	For cylinders, check the following items. <ol style="list-style-type: none"> <li>1) The rated supply pneumatic pressure and the supply amount are secure</li> <li>2) The bypass valve is closed.</li> <li>3) The operation air stop valve is open.</li> <li>4) The speed controller is open properly.</li> <li>5) The exhaust port lug has been removed.</li> </ol> For motors, check the following items. <ol style="list-style-type: none"> <li>1) The rated power voltage is supplied.</li> <li>2) Voltage is applied to the motor properly.</li> <li>3) The thermal protector, etc. is not activated.</li> <li>4) Two or more actuators are not operated with one switch.</li> <li>5) No water is inside the motor.</li> </ol> For details, refer to the instruction manual of each actuator.
	The valve body is deformed because abnormal force is applied.	If a support is installed to the valve neck section or actuator, the support may produce a force that deforms the valve. Remove the support member and check the valve.
	Abnormal interference of the disc due to damage or deformation of the seat.	Replace the Seat. If any abnormality is observed on the disc edge, replace the valve.
Parts, such as the disc, shaft, body and joint, are damaged.	If none of the above is applicable, the valve parts may be damaged, and replacement of the parts may be required. Please contact our sales department.	

MEMO :



4665 Interstate Drive  
Cincinnati, Ohio 45246  
PH: 513.731.2900  
[www.jflowcontrols.com](http://www.jflowcontrols.com)